

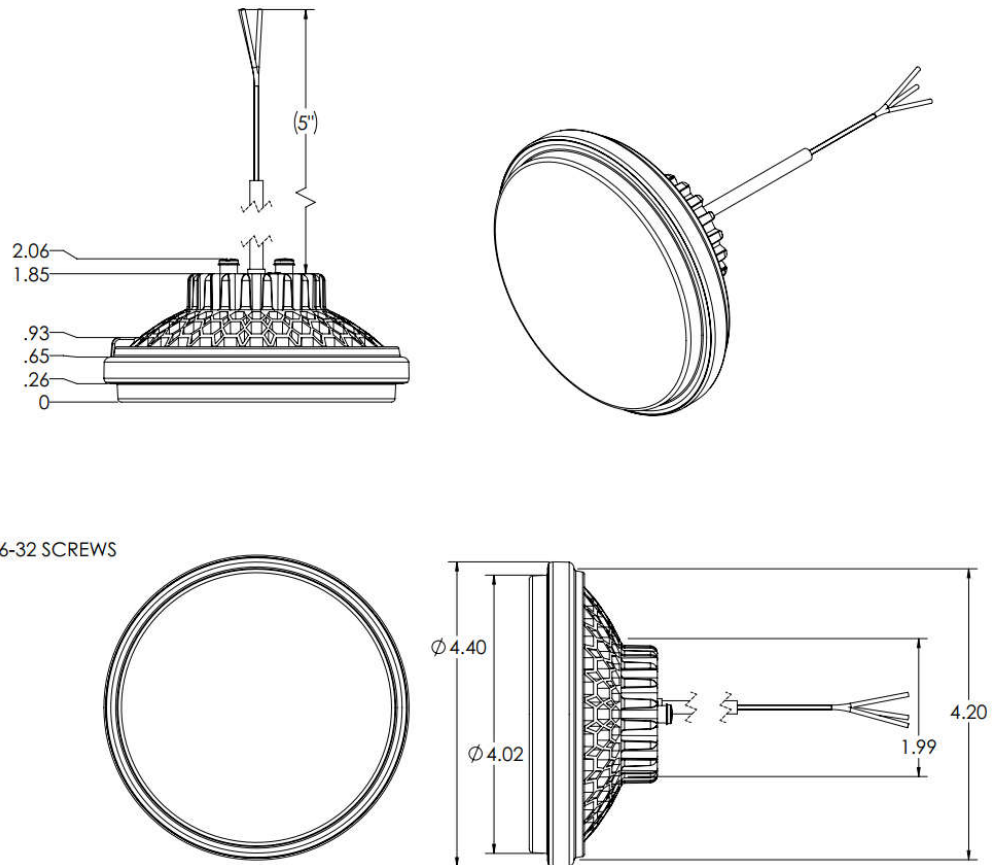

Product Datasheet

SunSpot 36-4596 Landing Light with Recognition 01-1030-4596-H



Voltage:	28V AC/DC	Length:	4.4"
Current:	3.6A at 28VDC	Width:	4.4"
Power:	100 Watts	Depth:	2.1"
Pulse/WigWag:	Built In	Weight:	11.5 Oz
Synchronization:	Built In	Heat Sink Material:	Aluminum/Black Powder Coat
Thermal Protection:	Built In	Lens Material:	Polycarbonate
Lumens:	11,000 lm	Lens Protection:	Optional Film
Candela:	150,000 cd	Mounting:	PAR 36 Ring Clamp
Beam Profile (@ 10% peak):	Vertical: 20°	MTBF	>30,000 Hours
	Horizontal: 20°	Temperature Range:	-55C to +70C